

HP110 – Portable Hydraulic Puncher Machine





A double action, fully automated process of punching and return, ready to work in both horizontal and vertical positions.

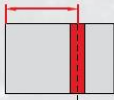

Features:

- Wide Range of hole diameters up to 27mm.
- Intelligent control system with inching and automatic load detection.
- Mode indicator light.
- Modern Construction.
- Protection against accidental start up.
- All connection ports located at the back.
- Broad range of special shaped punches and dies.
- Patent pending compact moveable hydraulic power pack.
- Accessible and simple operations for restricted areas.

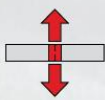

							
	max. thickness	max. throat depth	max. hole	max. oblong hole	punching time	punching power	double action hydraulic movement
PRO 60 HP	13 mm	60 mm	27 mm	25 x 18 mm	5 sec	35 ton	YES
PRO 110 HP	16 mm	110 mm	27 mm	25 x 18 mm	8 sec	47 ton	YES



SPECIFICATIONS

MODEL	HP110
Weight	20kg
Motor	1500 watts
Max. Thickness	16mm
Max. Throat Depth	110mm
Max. Hole	27mm
Max. Oblong Hole	25 x 18mm
Punching Time	8 seconds
Height	388mm
Length	479mm
Width	135mm
Punching Power	47 ton
Pump Output	1.5 L/min
Oil Capacity	10L
Double Action Hydraulic Movement	YES
Working Pressure	700 bar
Voltage	115V or 230V

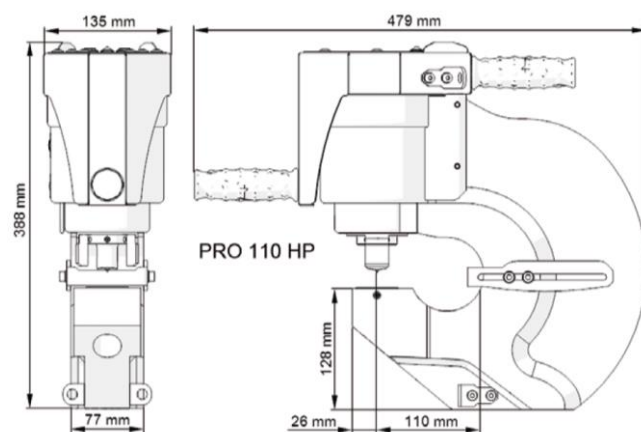
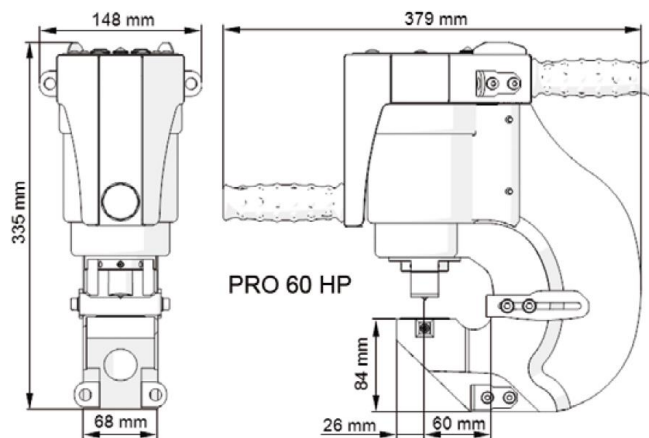

Ready to work in both vertical and horizontal positions



Portable hydraulic power pack with shelf for puncher transport.



Available 2 models of spring balancers.



Ergonomic location of ports at the back



High efficiency punches and dies

